

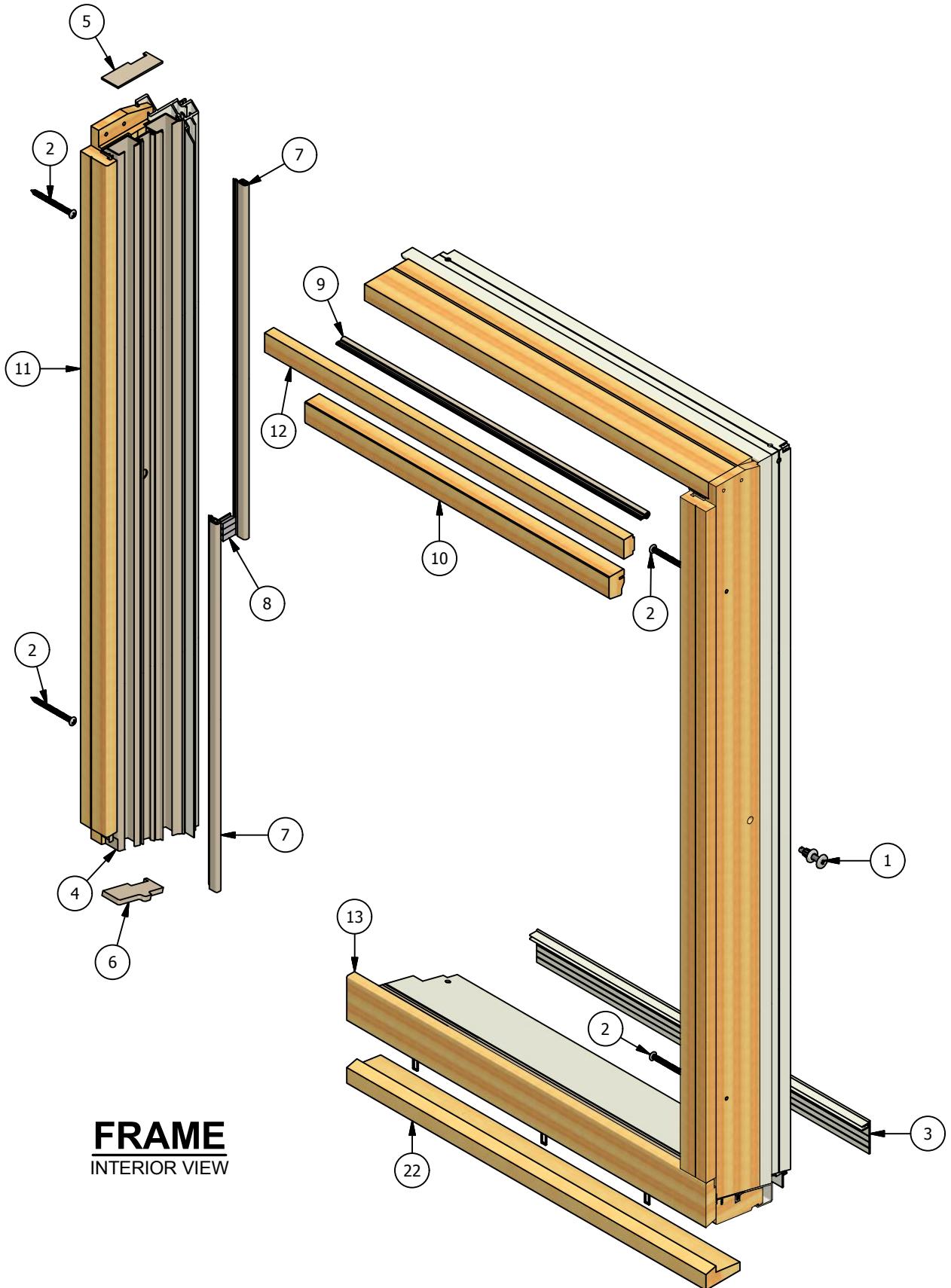

Revive Series Hybrid Double Hung (Operating) Parts Identification



FRAME
INTERIOR VIEW



Revive Series Hybrid Double Hung (Operating) Parts Identification

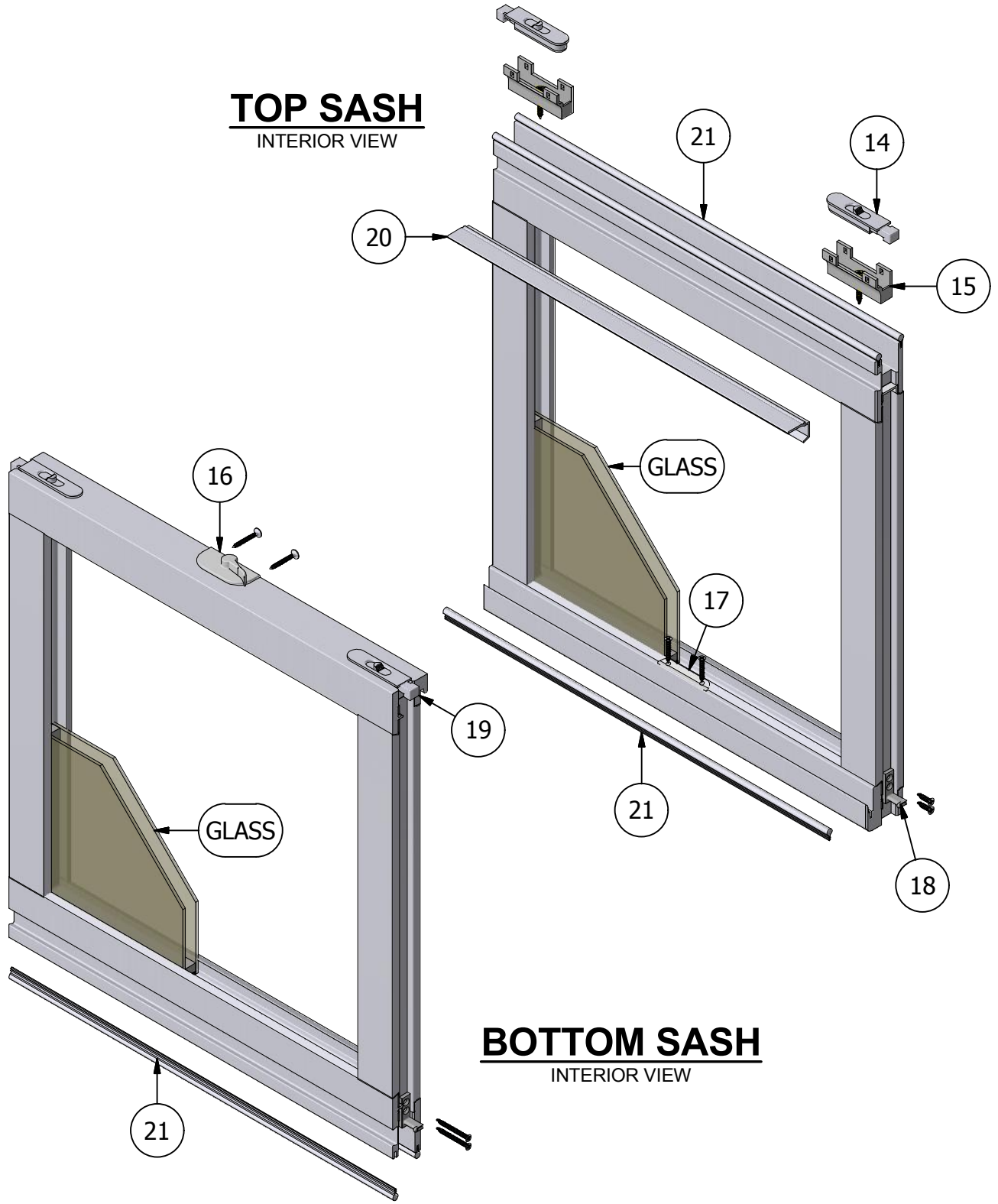





Revive Series

Hybrid Double Hung (Operating)

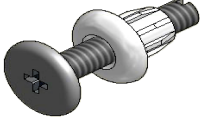
Parts Identification

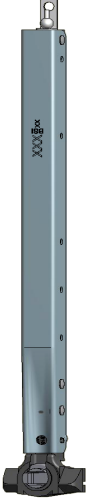

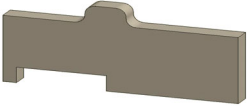

Image	Item #	Description	Color / Finish / Size	Spec	Old	New SAP
	1	Jamb Jack (Qty. 2)			558240	10054691
	2	Installation Screw #8 x 2-1/2" (Qty. 4)			500035	10056192
	3	Frame Expander (Head, Sill, & Jambs)			480027	10057108



Revive Series

Hybrid Double Hung (Operating)

Parts Identification

Image	Item #	Description	Color / Finish / Size	Spec	Old	New SAP
 Not Shown on Assembly Dwg		Inverted Block and Tackle Balance Balance Screw (#6 x 5/8")		*See Inside Sales for more Information	583125	10053112
	4	Jambliner Shell	Frame Height <= 64" Frame Height >64<= 80" Frame Height <= 64" Frame Height >64<= 80"	LH LH RH RH	584014 584016 584015 584017	10055067 10055647 10056429 10056430
	5	Jambliner Head Pad		LH/RH	583119 583120	N.L.A. 10055052
	6	Jambliner Sill Pad		LH & RH Pair	583118	10056311
	7	Jambliner Weatherstrip	Beige Bronze		583151 583150	10056316 10055594



Revive Series

Hybrid Double Hung (Operating)

Parts Identification

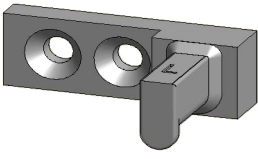
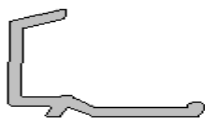

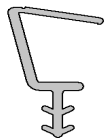

Image	Item #	Description	Color / Finish / Size	Spec	Old	New SAP
	8	Center Transition Cover			583112	10056710
	9	Parting Stop Weatherstrip			583114	10056310
	10	Parting Stop	5' Pine Lineal 5' Alder Lineal 5' Fir Lineal		2386902 2386902-A 2386902-F	10017802 10017803 10017804
	11	Jamb Inside Stop	9' Pine Lineal 9' Alder Lineal 9' Fir Lineal		2381965 2381965-A 2381965-F	10017680 10017681 10055834
	12	Head Inside Stop	5' Pine Lineal 5' Alder Lineal 5' Fir Lineal		584011 584011-A 584011-F	10024245 10024250 10024251
	13	Sill Inside Stop	8' Pine Lineal 11' Pre-Finished 11' Alder Lineal 8' Fir Lineal		2530200 2530201 2530200-A 2530200-F	10017946 10017947 10044693 10057385
	14	Upper Tilt Latch (LH Shown)		RH LH	557992 557993	10056279 10055224
	15	Upper Tilt Latch Housing (LH Shown) Upper Tilt Latch Housing Screw <small>(#8 x 1 1/4" Screw)</small>		RH LH	557998 557999 508117	10056282 10055574 10054957
	16	Lock with Screws	White Champagne Bronze Satin Nickel Faux Bronze		2382700 2382701 2382702 2382704 2382734	10055838 10055116 10055839 10055840 10055854



Revive Series

Hybrid Double Hung (Operating)

Parts Identification

Image	Item #	Description	Color / Finish / Size	Spec	Old	New SAP
	17	Keeper with Screws	White Champagne Bronze Satin Nickel Faux Bronze		2382690 2382693 2382692 2382694 2382691	10055352 10055837 10054995 10055353 10055836
	18	Tilt Pin (LH Shown) Tilt Pin Screws (48 x 1 1/2 x 7)		LH RH	583142 583143 8094	10056314 10055235 10056499
	19	Lower Tilt Latch (LH Shown) w/ Screws	LH - WHITE LH - CHAMPAGNE LH - BRONZE LH - SATIN NICKEL LH - FAUX BRONZE RH - WHITE RH - CHAMPAGNE RH - BRONZE RH - SATIN NICKEL RH - FAUX BRONZE		583126 583127 583128 583130 583133 583134 583135 583136 583138 583141	10056317 10055590 10056318 10056711 10056320 10055234 10056321 10055592 10055053 10055593
 Not Shown on Assembly Dwg	20	Window Opening Control Device	White		9410013	10117065
	21	Bulb Weatherstrip	White		538010	10055216
	22	Sash Checkrail Weatherstrip (After 2/6/17)	24" (Glass Size) 28" 32" 44"		538017 538018 538019 538020	10055558 10056249 10055046 10056250
	23	Zero Degree Sill Setting Block	Pine	14'	584012	10028281



Revive Series

Hybrid Double Hung (Operating)

Parts Identification

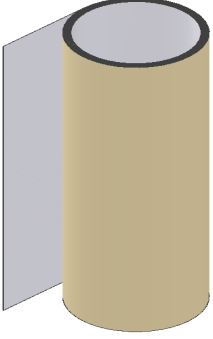
Image	Item #	Description	Color / Finish / Size	Spec	Old	New SAP
 Not Shown on Assembly Dwg	8	Coil Stock 0.019" x 24" x 50' Roll	Bronze / Linen White / Clay Black / Tan		420080 420081 420082	10056180 10055527 10056181