

Revive Series Clad Double Hung (Operating) Parts Identification

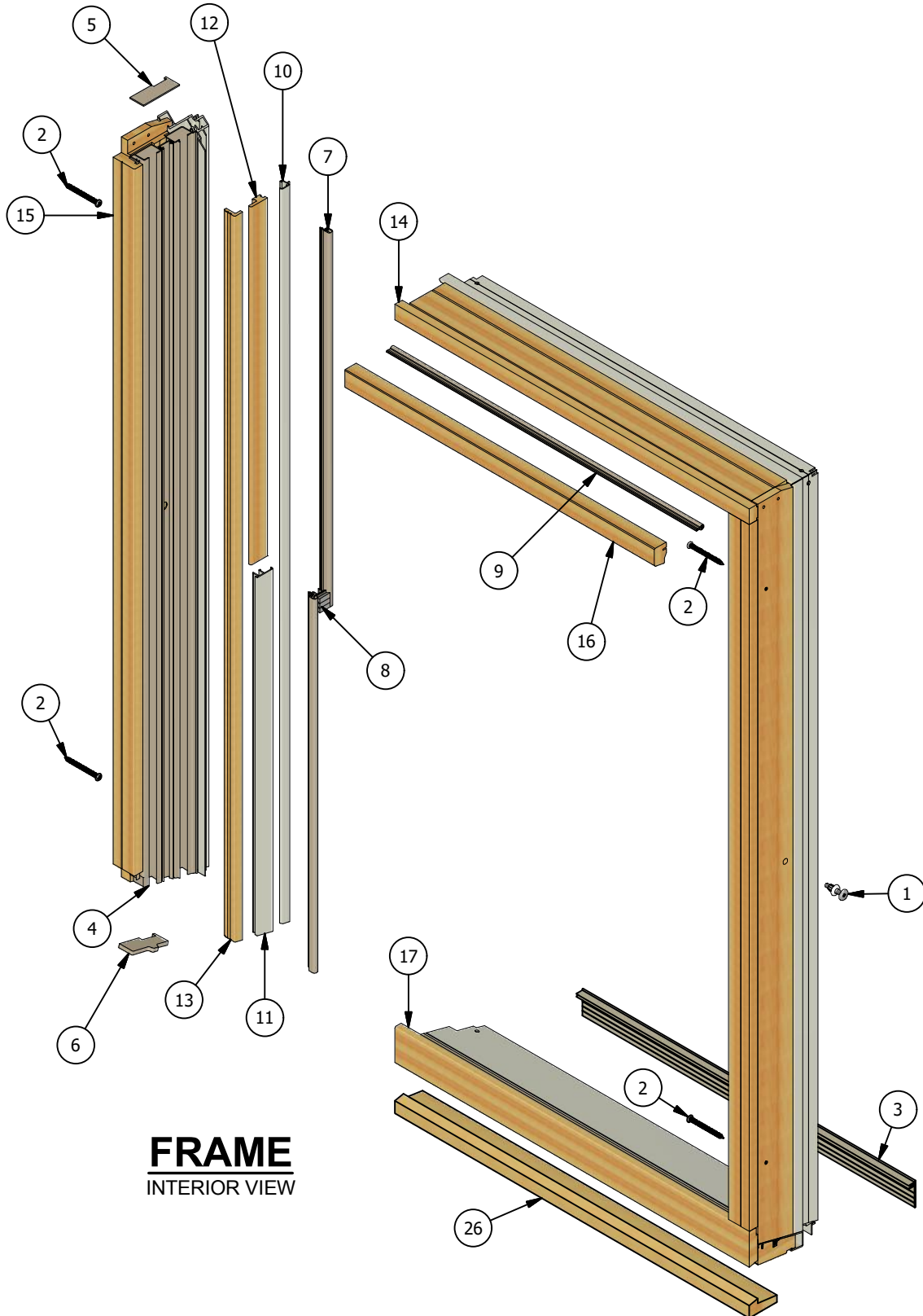

FRAME
INTERIOR VIEW



Revive Series Clad Double Hung (Operating) Parts Identification

TOP SASH INTERIOR VIEW

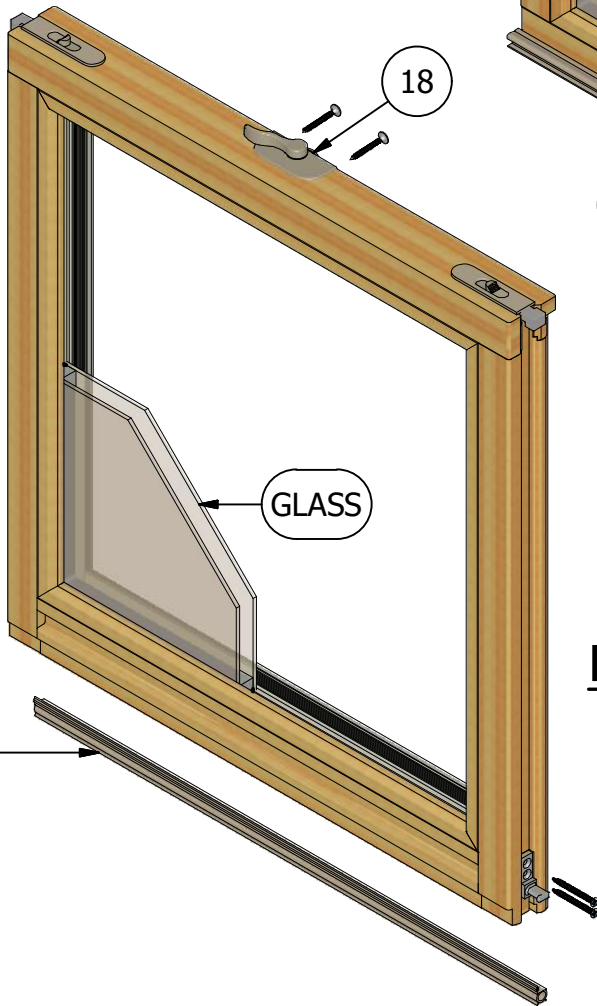
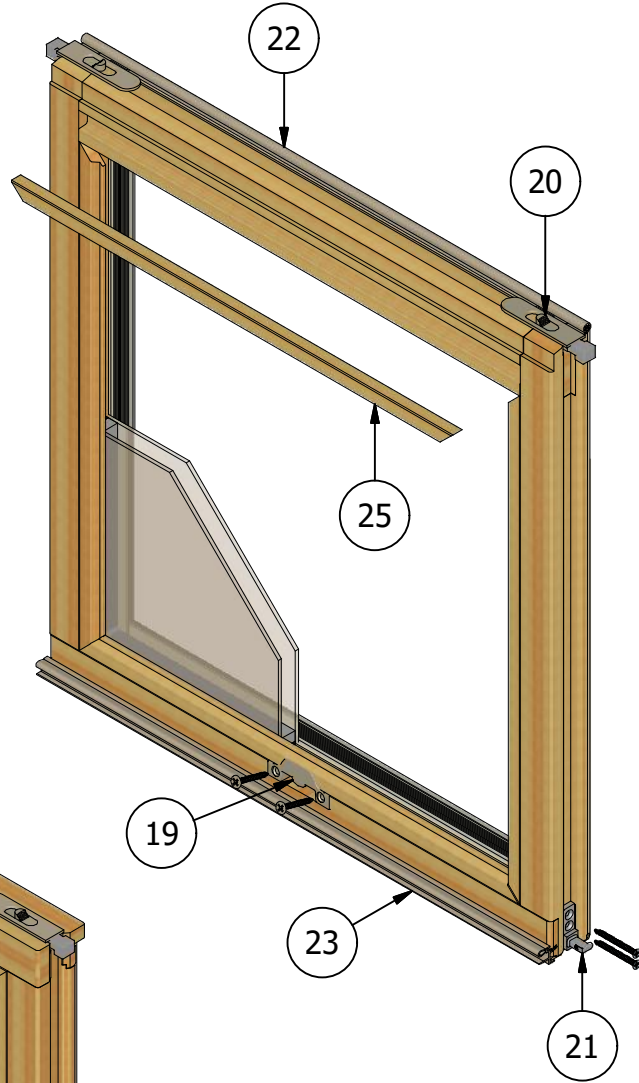



BOTTOM SASH INTERIOR VIEW



Revive Series

Clad Double Hung (Operating)

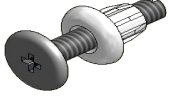
Parts Identification

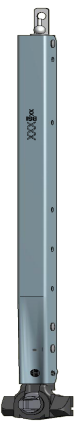



Image	Item #	Description	Color / Finish / Size	Spec	Old	New SAP
	1	Jamb Jack			558240	10054691
	2	Installation Screw #8 x 2-1/2" (Qty. 4)			500035	10056192
	3	Frame Expander (Head, Sill, & Jambs)			480027	10057108
 Not Shown on Assembly Dwg		Inverted Block and Tackle Balance Balance Screw (#6 x 5/8")		*See Inside Sales for more Information	583125	10053112



Revive Series

Clad Double Hung (Operating)

Parts Identification

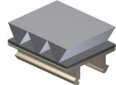
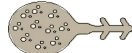
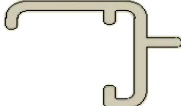
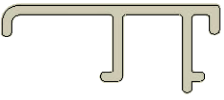
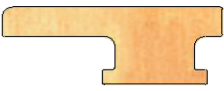
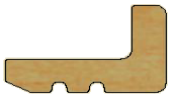

Image	Item #	Description	Color / Finish / Size	Spec	Old	New SAP
	4	Jambliner Shell	9' Lineal		583100	10055582
	5	Jambliner Head Pad		LH/RH	583119 583120	N.L.A. 10055052
	6	Jambliner Sill Pad		LH & RH Pair	583118	10056311
	7	Jambliner Weatherstrip	Beige Bronze		583151 583150	10056316 10055594
	8	Center Transition Cover			583112	10056710
	9	Parting Stop Weatherstrip			583114	10056310
	10	Exterior Jambliner Cover			583008 583011 583012 583014	10057620 No Longer Available
<p>*When ordering aluminum lieals in 2604 or 2605 standard or feature color, please order the mill part number to that extrusion, then specify color and either 2604 or 2605 finish.</p>						



Revive Series

Clad Double Hung (Operating)

Parts Identification

Image	Item #	Description	Color / Finish / Size	Spec	Old	New SAP
	11	Lower Center Jambliner Cover	Mill Finish*		583016 583019 583020 583022	10057187 No Longer Available
	12	Upper Center Jambliner Cover	6' Pine Lineal 6' Alder Lineal 6' Fir Lineal		2386901 2386901-A 2386901-F	10017799 10017800 10017801
	13	Interior Jambliner Cover	9' Pine Lineal 9' Alder Lineal 9' Fir Lineal		2386907 2386907-A 2386907-F	10017813 10017814 10056032
	14	Head Inside Stop	9' Pine Lineal 9' Alder Lineal 9' Fir Lineal		584011 584011-A 584011-F	10024245 10024250 10024251
	15	Side Inside Stop	9' Pine Lineal 9' Alder Lineal 9' Fir Lineal		2381965 2381965-A 2381965-F	10017680 10017681 10055834
<p>*When ordering aluminum lieals in 2604 or 2605 standard or feature color, please order the mill part number to that extrusion, then specify color and either 2604 or 2605 finish.</p>						



Revive Series

Clad Double Hung (Operating)

Parts Identification

Image	Item #	Description	Color / Finish / Size	Spec	Old	New SAP
	16	Parting Stop	5' Pine Lineal 5' Alder Lineal 5' Fir Lineal		2386902 2386902-A 2386902-F	10017802 10017803 10017804
	17	Sill Inside Stop	8' Pine Lineal 11' Pre-Finished Lineal 11' Alder Lineal 8' Fir Lineal		2530200 253029 2530200-A 2530200-F	10017946 10044693 10057385
	18	Lock with Screws	White Champagne Bronze Oil Rubbed Bronze Satin Nickel Brass Black Faux Bronze		2382700 2382701 2382702 2382703 2382704 2382705 2382706 2382734	10055838 10055116 10055839 10055354 10055840 10054905 10056640 10055854
	19	Keeper with Screws	White Champagne Bronze Oil Rubbed Bronze Satin Nickel Brass Black Faux Bronze		2382710 2382711 2382712 2382713 2382714 2382715 2382716 2382735	10055841 10055355 10055842 10055117 10055843 10055356 10055844 10055360



Revive Series

Clad Double Hung (Operating)

Parts Identification





Image	Item #	Description	Color / Finish / Size	Spec	Old	New SAP
	20	Tilt Latch with Screws (LH Shown) (Top & Bottom Sash)	White	LH	583126	10056317
				RH	583134	10055234
			Champagne	LH	583127	10055590
				RH	583135	10056321
			Bronze	LH	583128	10056318
				RH	583136	10055592
			Oil Rubbed Bronze	LH	583129	10054899
				RH	583137	10056322
			Satin Nickel	LH	583130	10056711
				RH	583138	10055053
		Brass	LH	583131	10056319	
			RH	583139	10056712	
		Black	LH	583132	10055591	
			RH	583140	10056323	
		Faux Bronze	LH	583133	10056320	
			RH	583141	10055593	
	21	Tilt Pin (LH Shown)		LH	583142	10056314
				RH	583143	10055235
		Tilt Pin Screws (#6 x 1-1/2 YZ)			8094	10056499
	22	Top Rail Weatherstrip	Beige		2381375	10055813
	23	Check Rail Weatherstrip	Beige: 6' Lineal Length		2381659	10055830
			Black: 6' Lineal		2381709	10055351



Revive Series

Clad Double Hung (Operating)

Parts Identification

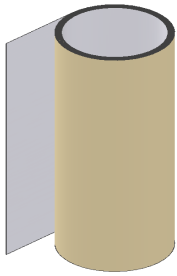
Image	Item #	Description	Color / Finish / Size	Spec	Old	New SAP
	24	Bottom Rail Weatherstrip	Beige Bronze		2381381 2381382	10055110 10055815
	25	Ogee Glass Stop	8' Pine Lineal 8' Alder Lineal 6' Fir Lineal		2381090 2381090-A 2381090-F	10017516 10017517 10017518
 Not Shown on Assembly Dwg		Contemporary Glass Stop	8' Pine Lineal 8' Alder Lineal 8' Fir Lineal		2922303 2922303-A 2922303-F	10020721 10020722 10057394
	26	Zero Degree Sill Setting Block	Pine	14'	584012	10028281
 Not Shown on Assembly Dwg		Coil Stock 0.019" x 24" x 50' Roll	Bronze / Linen White / Clay Black / Tan		420080 420081 420082	10056180 10055527 10056181



Revive Series

Clad Double Hung (Operating)

Parts Identification

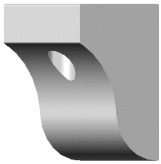
Image	Item #	Description	Color / Finish / Size	Spec	Old	New SAP
	18	Ogee Lug Kits - 2604 Finish	White		47500	
			Linen		47501	
			Ivory		47502	
			Sandstone		47503	
			Clay		47504	
			Tan		47505	
			Sage Brown		47506	
			Walnut		47507	
			Desert Dust		47508	
			Appalachian Brown		47509	
			Bronze		47510	
			Red River Rouge		47511	
			Cinnamon		47512	
			Sage Green		47513	
			Hunter Green		47514	
			Military Blue		47515	
			Clear		47516	
			Dove Gray		47517	
			Slate Gray		47518	
			Chacoal Gray		47519	
			Sable		47520	
			Black		47521	
			French Vanilla		47522	
			Burnt Sun		47523	
			Pueblo Tan		47524	
			Dijon		47525	
			Beige		47526	
			Coastal Tan		47527	
			Sierra Tan		47528	
			Putty		47529	
			Antique Bronze		47530	
			Sunflower		47531	
			Burnt Pumpkin		47532	
			Brick Red		47533	
			Redwood		47534	
			Royzenberry		47535	
			Patina Green		47536	
			Camarillo Green		47537	
			Midnight Blue		47538	
			Stormy Monday		47539	
Dark Bronze		47540				
Copper		47541				
Textured Black		47543				
Matte Black		47544				
Matte Bronze		47545				
Matte Tan		47546				
Matte Slate Gray		47547				
Matte Charcoal Gray		47548				
Matte Desert Dust		47549				
Matte Sable		47550				
Iron		47596				
Custom Color		47542				
Not Shown on Assembly Dwg						



Revive Series

Clad Double Hung (Operating)

Parts Identification

Image	Item #	Description	Color / Finish / Size	Spec	Old	New SAP
	18	Ogee Lug Kits - 2605 Finish	White		47551	
			Linen		47552	
			Ivory		47553	
			Sandstone		47554	
			Clay		47555	
			Tan		47556	
			Sage Brown		47557	
			Walnut		47558	
			Desert Dust		47559	
			Appalachian Brown		47560	
			Bronze		47561	
			Red River Rouge		47562	
			Cinnamon		47563	
			Sage Green		47564	
			Hunter Green		47565	
			Military Blue		47566	
			Clear		47567	
			Dove Gray		47568	
			Slate Gray		47569	
			Chacoal Gray		47570	
			Sable		47571	
			Black		47572	
			French Vanilla		47573	
			Burnt Sun		47574	
			Pueblo Tan		47575	
			Dijon		47576	
			Beige		47577	
			Coastal Tan		47578	
			Sierra Tan		47579	
			Putty		47580	
			Antique Bronze		47581	
			Sunflower		47582	
			Burnt Pumpkin		47583	
Brick Red		47584				
Redwood		47585				
Roysenberry		47586				
Patina Green		47587				
Camarillo Green		47588				
Midnight Blue		47589				
Stormy Monday		47590				
Dark Bronze		47591				
Copper		47592				
Textured Black		47594				
Iron		47595				
Custom Color		47593				
Not Shown on Assembly Dwg		Ogee Lug Screws (Included in Lug Kit)	#8 x 1" Pan Head Screw	Qty. 2	508051	
Not Shown on Assembly Dwg						