

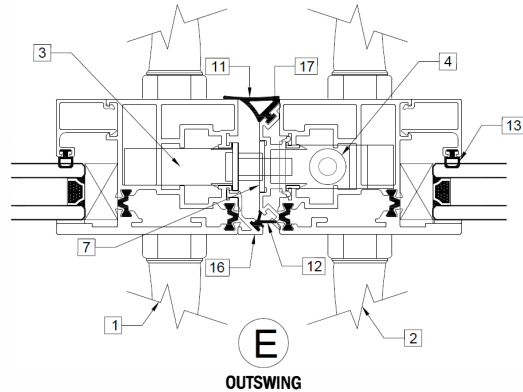

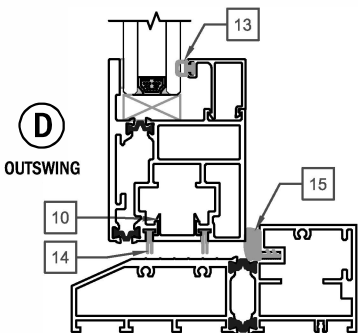

PINNACLE SELECT OUTSWING (Aluminum Interior)

PART LIST

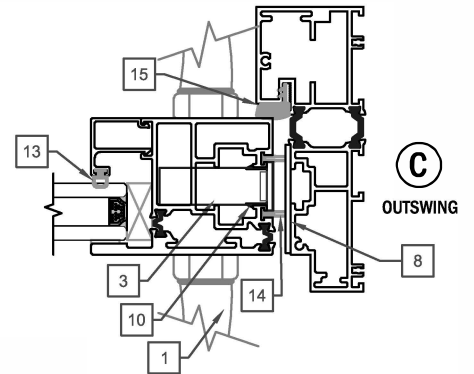
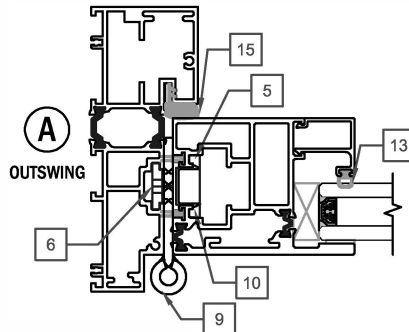
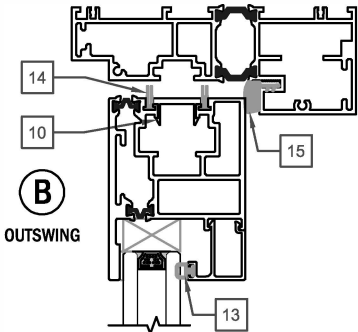
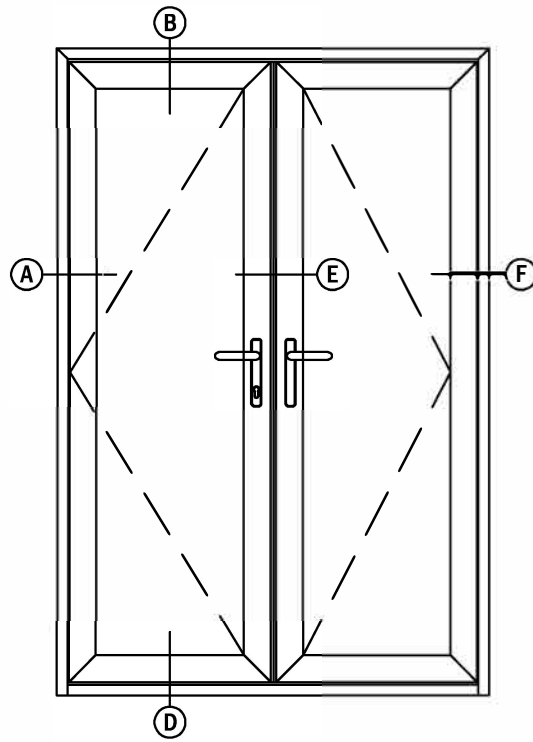
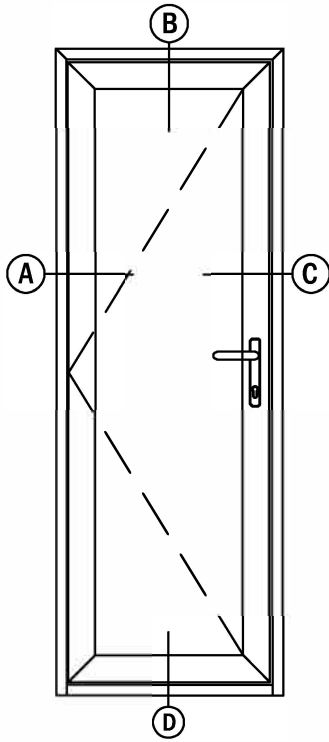

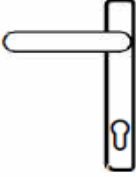
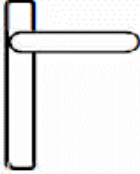







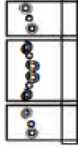

PINNACLE SELECT OUTSWING (Aluminum Interior)

PART LIST

IMAGE	ITEM #	DESCRIPTION	TYPE	OLD	NEW SAP
	1	ARIA HANDLE (ACTIVE PANEL) ACACIA HANDLE (ACTIVE PANEL) SUMMIT HANDLE (ACTIVE PANEL)	BLACK BRONZE WHITE SATIN CHROME BLACK BROWN WHITE SATIN CHROME BLACK BRONZE WHITE SATIN CHROME	48000 48001 48002 48003 48004 48005 48006 48007 48008 48009 48010 48011	10120574 10120575 10120579 10120580 10120581 10120582 10120583 10120584 10120585 10120586 10120587 10120588
	2	ARIA HANDLE (INACTIVE PANEL) ACACIA HANDLE (INACTIVE PANEL) SUMMIT HANDLE (INACTIVE PANEL)	BLACK BRONZE WHITE SATIN CHROME BLACK BROWN WHITE SATIN CHROME BLACK BRONZE WHITE SATIN CHROME	48012 48013 48014 48015 48016 48017 48018 48019 48020 48021 48022 48023	10120589 10120590 10120590 10120591 10120592 10120594 10120595 10120596 10120597 10120598 10120599 10120600
	3	LOCKING MECHANISM (ACTIVE PANEL)	3-POINT LOCK 4-POINT LOCK	48024 48025	10120601 10120602
	4	LOCKING MECHANISM (INACTIVE PANEL)	2-POINT LOCK	48026	10120603
	5	PANEL HINGE RECEIVER	STAINLESS STEEL	48027	10120604
	6	SIDE FRAME HINGE RECEIVER	STAINLESS STEEL	48028	10120605

PINNACLE SELECT OUTSWING (Aluminum Interior)

PART LIST

IMAGE	ITEM #	DESCRIPTION	TYPE	OLD	NEW SAP
	7	BI-PART STRIKE PLATE	ALUM. PC TO MATCH	48029	10120606
	8	SIDE FRAME STRIKE PLATE	ALUM. PC TO MATCH	48030	10120607
	9	HINGE	SATIN CHROME DARK BRONZE	48031 48032	10120608 10120609
	10	PANEL SIDE COVER	ALUM. PC TO MATCH	48033	10120610
	11	BI-PART GASKET	BLACK	48034	10120611
	12	BI-PART GASKET	BLACK	48100	10119087
	13	INT. GLAZING GASKET	BLACK	48036	10120613
	14	PANEL SIDE GASKET	BLACK	48037	10120614
	15	FRAME GASKET	BLACK	48038	10120615
	16	DRAINAGE CAP	BLACK	48039	10120616
	17	ACTIVE PANEL BI-PART CLIP	ALUM. PC TO MATCH	48041	10120618
	18	INACTIVE PANEL BI-PART CLIP	ALUM. PC TO MATCH	48042	10120619