

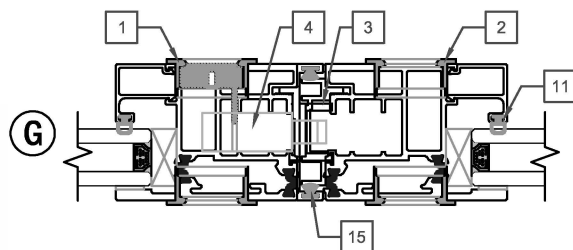

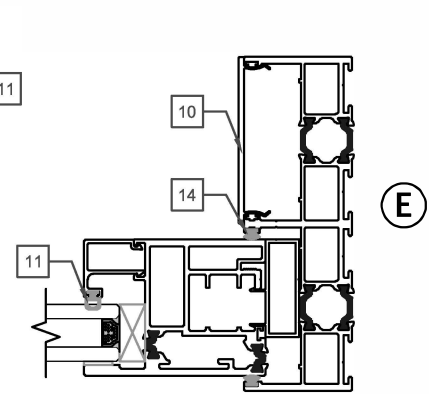

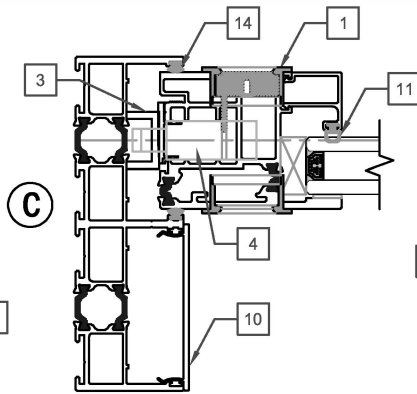

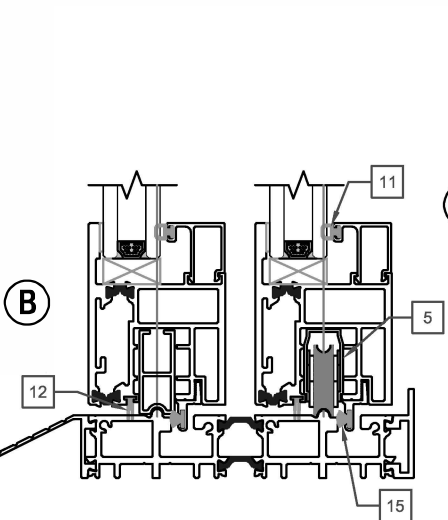

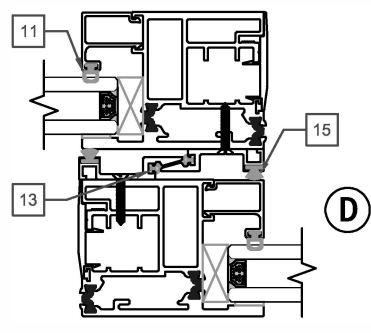
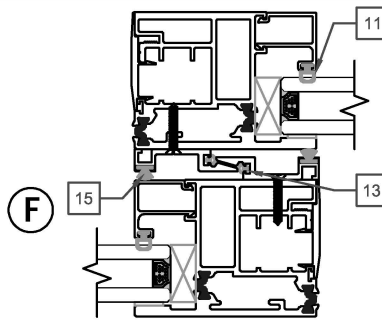
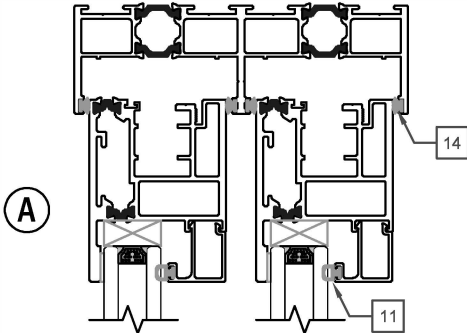
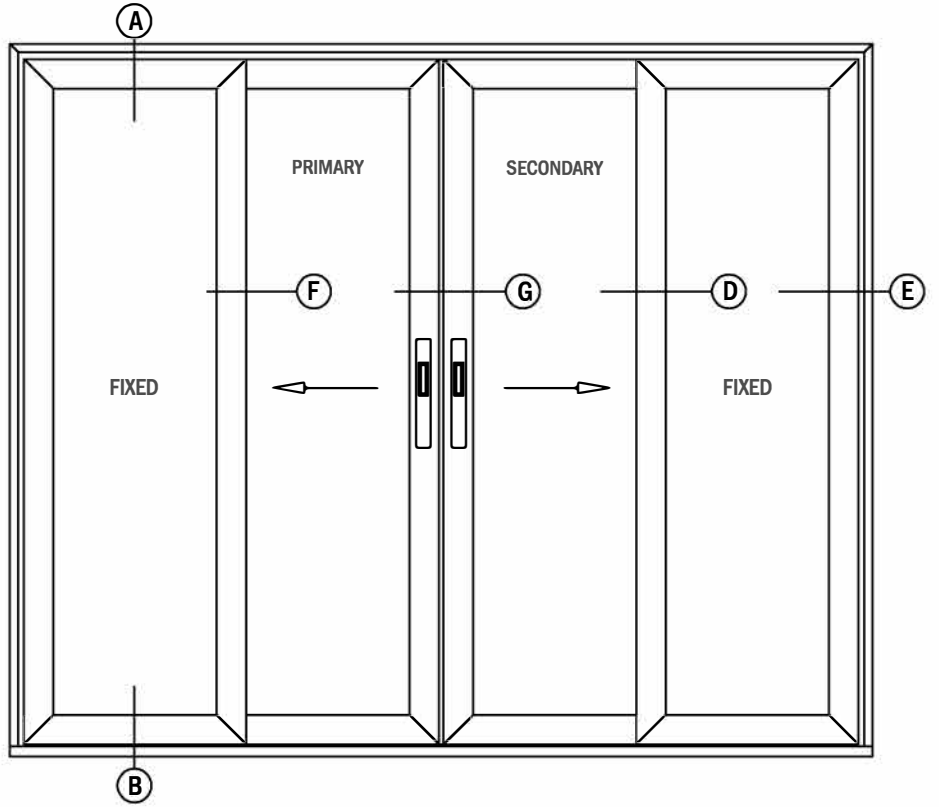
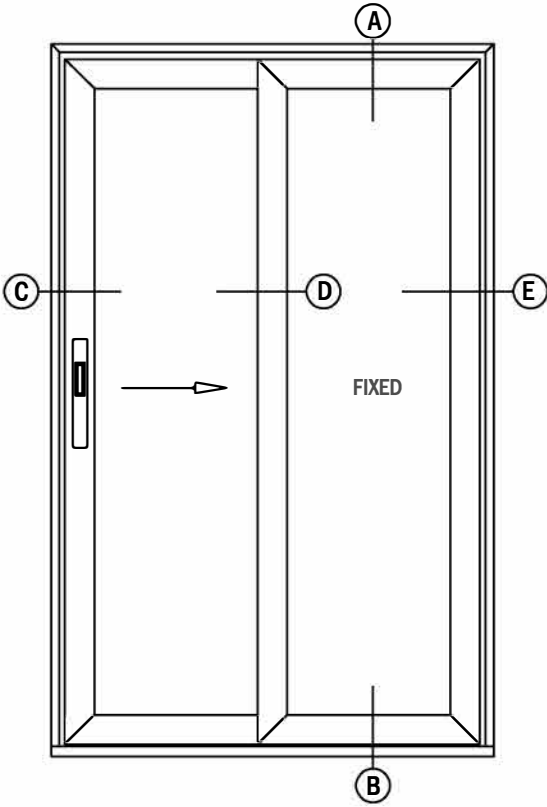







DBB57@G9@7HA | @HG@89(Aluminum Interior)

PART LIST



DBB57@9G9@7HA | @HG@89(Aluminum Interior)

PART LIST

45; 9	#PA ;	89G7F-DHCB	HND9	C@B	B9K G5D
	%	H@J) \$\$ r1DF-A 5FMD5B9@	6@57? 6FCBNP K <#P" G5HB 7F <CA 9	(, \$((, \$((, \$* (, \$(+	%'& %'&& %'&*' %'&*&
		H@J) \$\$ <5B8@r1@97CB85FMD5B9@	6@57? 6FCBNP K <#P" G5HB 7F <CA 9	(, \$(, (, \$(- (, \$)\$ (, \$)%	%'& %'&*' %'&*'+ %'&*&
	'	H@J) \$\$ 58; GH56@9799D9F	GH5-B@9GGG-H9@	(, \$) &	%'&*&
	(H@J) \$\$ @7?; B; A 97<5B-GA	&DC-BH@7?	(, \$)'	%'&*' \$
)	K <99@ 8I 5@K <99@ EI 58K <99@r) \$ GE": H/ 1 D	; F5M 6@57?	(, \$)((, \$))	%'&*' % %'&*' &
	*	#BH@7? 6CHCA 75D F@ <HG57? r@LH@-CF J-9K L	6@57?	(, \$) *	%'&*' ''
	+	#BH@7? HCD75D F@ <HG57? r@LH@-CF J-9K L	6@57?	(, \$) +	%'&*' (
	'	#BH@7? 6CHCA 75D @ HG57? r@LH@-CF J-9K L	6@57?	(, \$),	%'&*')
	-	#BH@7? HCD75D @ HG57? r@LH@-CF J-9K L	6@57?	(, \$) -	%'&*' *
	%\$	G-89: F5A 9#<9589F 75D	D7HC'A 5HT<	(, \$*\$	%'&*' +
	%%	#BH; @NB; ; 5G?9H	6@57?	(, \$) *	%'&*' %
	%&	D5B9@F 5-@ 5G?9H	6@57?	(, \$) +	%'&*' %&
	%	#BH@7?; 5G?9H	6@57?	(, \$) %	%'&*' ,
	%&	GA 5@65G9: 9@H6FI G< rG-89: F5A 9CB@M	6@57?	(, \$)(%'&*' -
	%@	@F; 965G9: 9@H6FI G< rG-89: F5A 9CB@M	6@57?	(, \$)	%'&*' (\$