

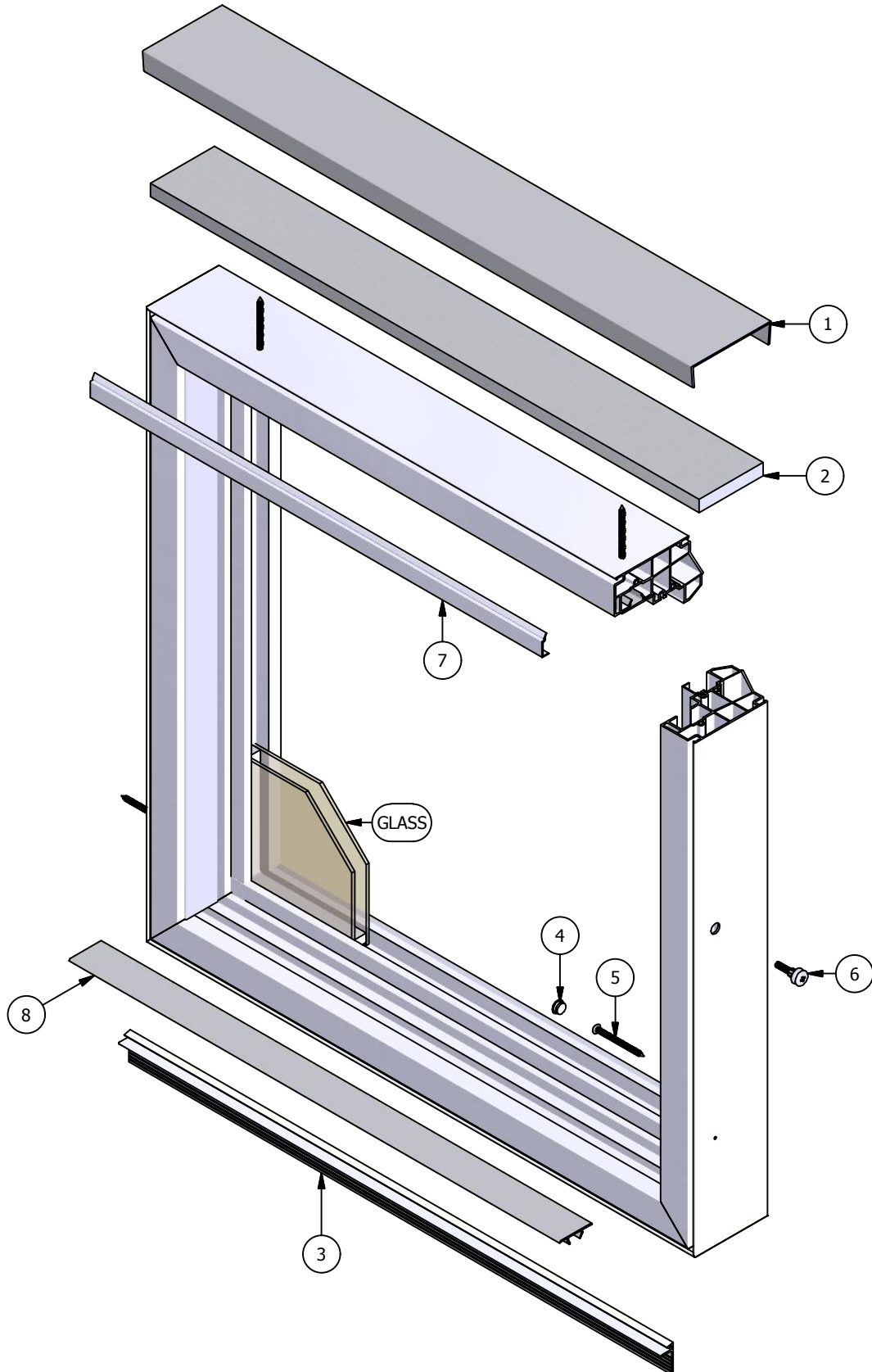

Revive Series

Vinyl Double Hung (Fixed)

Parts Identification











Revive Series

Vinyl Double Hung (Fixed)

Parts Identification

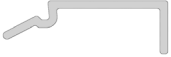

Image	Item #	Description	Color / Finish	Spec	Old	New SAP
	1	Head Expander (Qty. 1)	White Clay		900755 901855	10054630 10054252
	2	Head Expander Foam (Qty. 1)			2388409	10054569
	3	Sill Cover (Qty. 1)	White Clay		900760 901860	10054722 10054055
	4	Hole Cap (Qty. 4)	White Clay Black		558242 558245 558529	10054614 10054692 10054354
	5	Frame Screw #8 x 2" (Qty. 4)			518200	10056223
	6	Jamb Jack (Qty. 2)			558240	10054691



Revive Series

Vinyl Double Hung (Fixed)

Parts Identification

Image	Item #	Description	Color / Finish	Spec	Old	New SAP
	7	Glazing Bead	White Clay Bronze Black Tan Ivory Cinnamon Green White	16'	920009 920044 920009-BZ 920009-BK 920009-T 920009-I 920009-C 920009-G 920009-W	10055282 10054413 10116681 10116682 10116678 10116680 10116679 10116676 10116677
No Image		Glazing Tape 1/16" x 1/2"	White	216' Roll	394100	10055200
	8	Interior Pocket Cover	White Clay	16'	920010 920045	10054726 10054633