

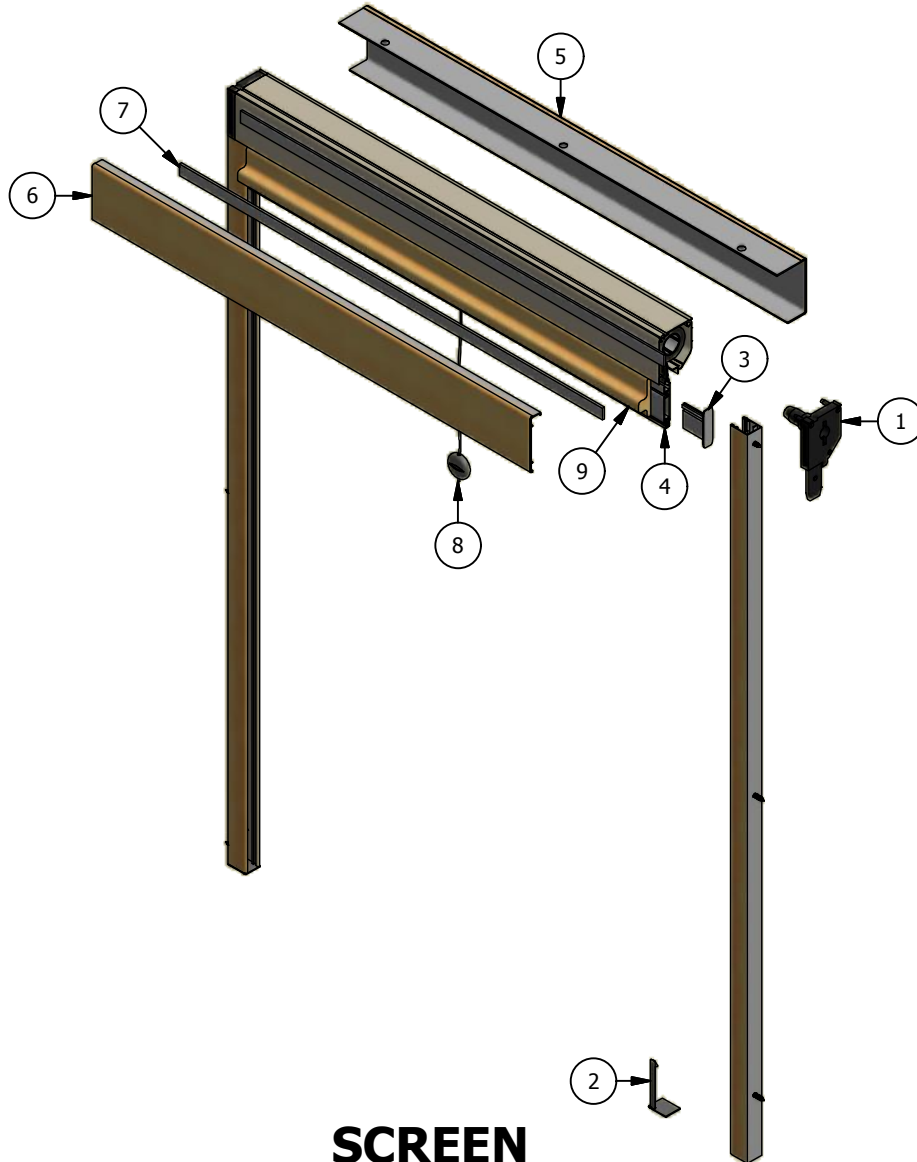

# Pinnacle Select Series Retractable Screen

## Parts Identification









**SCREEN**  
INTERIOR VIEW



# Pinnacle Select Series Retractable Screen



## Parts Identification

Image	Item #	Description	Color / Finish / Size	Spec	Old	New SAP
		Retractable Screen Assembly (Screws Included)				
	1	Cassette End Cap (RH Shown)		RH LH	659893 659894	10054923 10056733
	2	End Cap/Latch for Guide (RH Shown)		RH LH	659891 659892	10055660 10056456
	3	Pull Bar End Cap (RH Shown)		RH LH	659895 659896	10056457 10055662
	4	Pile Weatherstrip		LF	659897	10056458
No Image		Screw Pack & Warning Label #6 x 3/4" (Qty.8)			659898	10057660
	5	Outside Screen Cover  Outside Screen Cover Screws #8 x 3/4" Screw	8' Mill Veneer 14' Pine Veneer 14' Fir Veneer 14' Alder Veneer		2391363 2391364 2391365 2391366  508152	10056832 10057748 10057367 10057061  10053263
	6	Inside Screen Cover	8' Mill Veneer 14' Pine Veneer 14' Fir Veneer 14' Alder Veneer		2391359 2391360 2391361 2391362	10056910 10057365 10057060 10057366
No Image	7	Inside Screen Cover Tape 1/8" x 1/2" Double Sided	White - 108' Roll		394101	10057454



# Pinnacle Select Series Retractable Screen

## Parts Identification

Image	Item #	Description	Color / Finish / Size	Spec	Old	New SAP
	8	Screen Pull Cord (Optional)			671100	10057664
	9	Wood Pull	8' Pine Lineal 8' Alder Lineal 8' Fir Lineal		590173 590173-A 590173-F	10042292 10032058 10057203